

## DESCRIPTION

AMCOM's AM264240WM-BM/FM-R is part of the GaAs HIFET MMIC power amplifier series. It is a 2-stage GaAs HIFET PHEMT MMIC power amplifier. It is fully matched to 50-ohm at both input and output, covering 2.6 to 4.2GHz. It has 20dB gain and 40dBm output power at 14V. This MMIC is in a ceramic package with both RF and DC leads at the lower level of the package to facilitate low-cost SMT assembly to the PC board. When mounting directly to PCB, please see application note AN700 for instructions. Because of high DC power dissipation, we strongly recommend to mount these devices directly on a metal heat sink. The AM264240WM-FM-R is the AM264240WM-BM-R mounted on a gold plated copper flange carrier. There are two screw holes on the flange to facilitate screwing on to a metal heat sink. This MMIC is RoHS compliant.

## FEATURES

- High Bandwidth, 2.6 to 4.2GHz
- High output power, P1dB = 39dBm
- Small Signal Gain of 20dB

## APPLICATIONS

- PCS Pico Cell Base Station
- GPS Applications
- WiMAX
- WLL
- 10V – 15V Applications

## RF PERFORMANCE

Measured on a test board at  $V_{dd} = +14V$ ,  $V_{gs} = -0.95V^{**}$ ,  $I_{dq} = 1500mA$ ,  $T_a = 25^{\circ}C$

Parameters	Minimum	Typical	Maximum
Frequency	3.0 – 3.8GHz	2.6 – 4.2GHz	
Small Signal Gain	17dB	20dB	
Gain Ripple		± 1.0dB	± 2.0dB
P1dB	37dBm	39dBm	
Psat		40dBm	
IP3		50dBm	
Efficiency @ P1dB		35%	
Input Return Loss	6dB	8dB	
Output Return Loss	10dB	13dB	
Thermal Resistance		5°C/W	

\* Specifications subject to change without notice.

\*\*  $V_{gs}$  could vary from lot to lot. It should be adjusted to get the correct  $I_{dq}$  value

## ABSOLUTE MAXIMUM RATING

Parameters	Symbol	Rating
Drain source voltage	$V_{dd}$	+16V
Gate source voltage	$V_{gs}$	-5V
Drain source current	$I_{dd}$	2.0A
Continuous dissipation at room temperature	$P_t$	25W
Channel temperature	$T_{ch}$	175°C
Operating ambient temperature	$T_{op}$	-40°C to +85°C
Storage temperature	$T_{sto}$	-55°C to +135°C

LINEAR DATA ( $V_{dd} = +14V$ ,  $V_{gs} = -0.95V^{**}$ ,  $I_{dq} = 1500mA$ ,  $T_a = 25^{\circ}C$ )

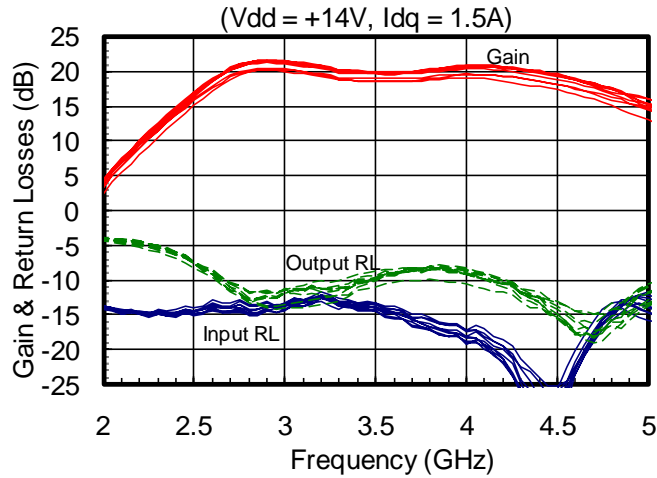

\*\*  $V_{gs}$  could vary from lot to lot. It should be adjusted to get the correct  $I_{dq}$  value

**POWER DATA**

A) Output power and efficiency at P1dB and P3dB at different biases

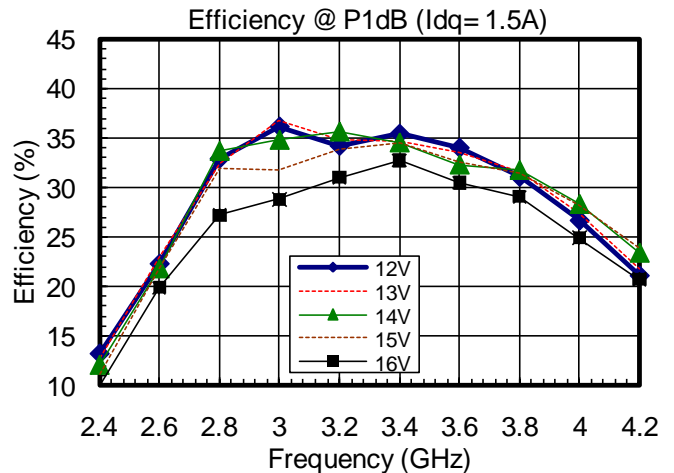
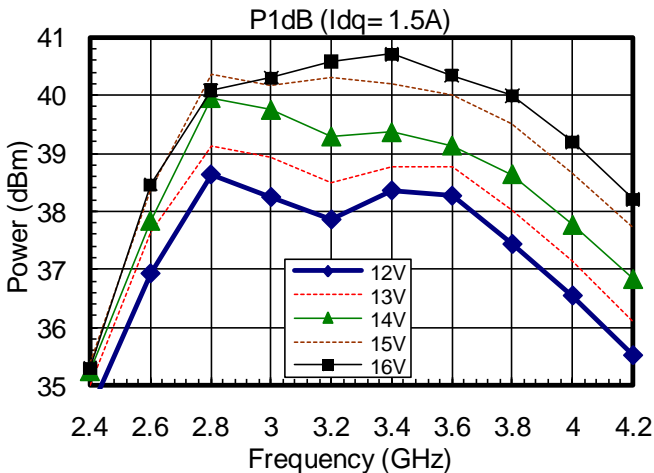
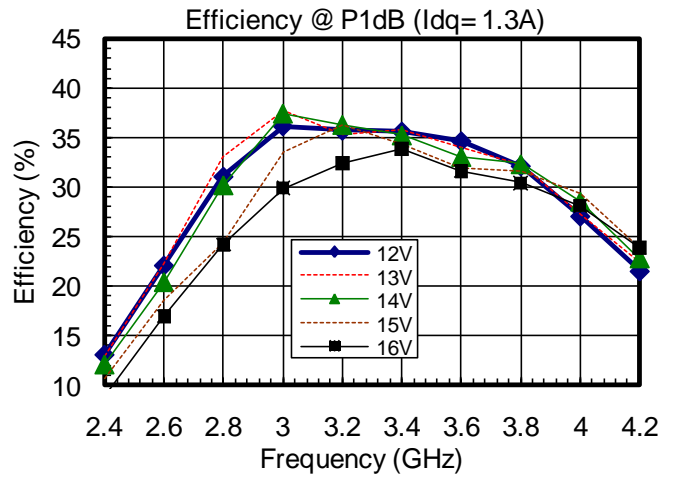
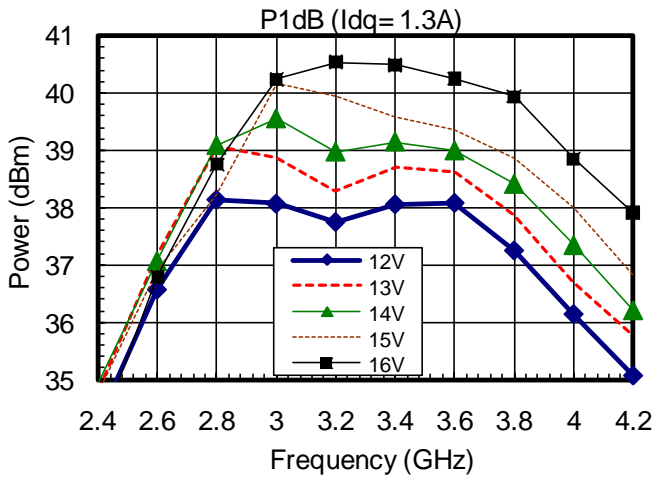

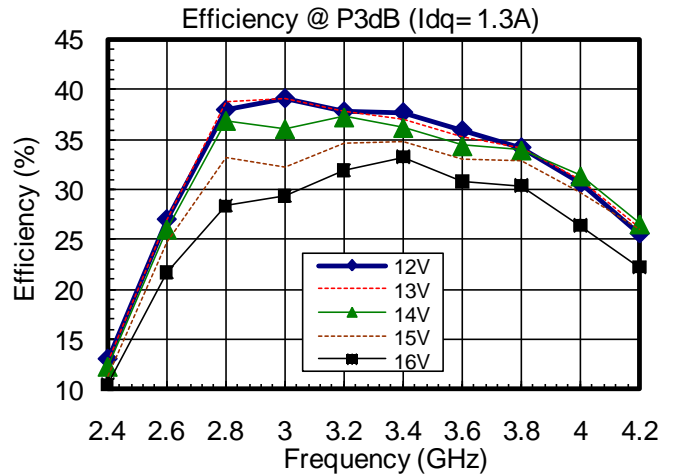
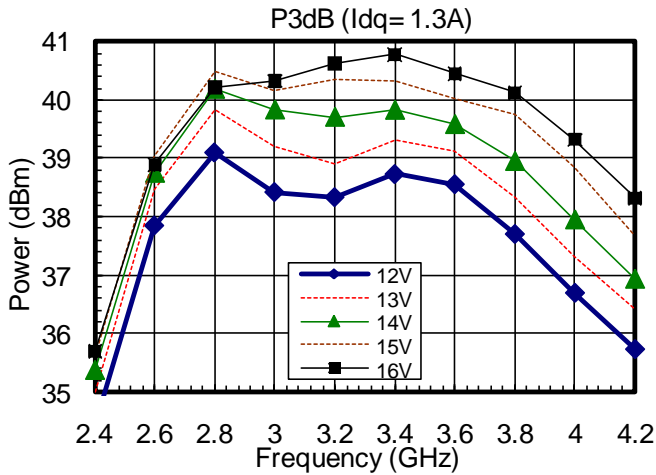

B) IP3 & IP5 at 28dBm output power

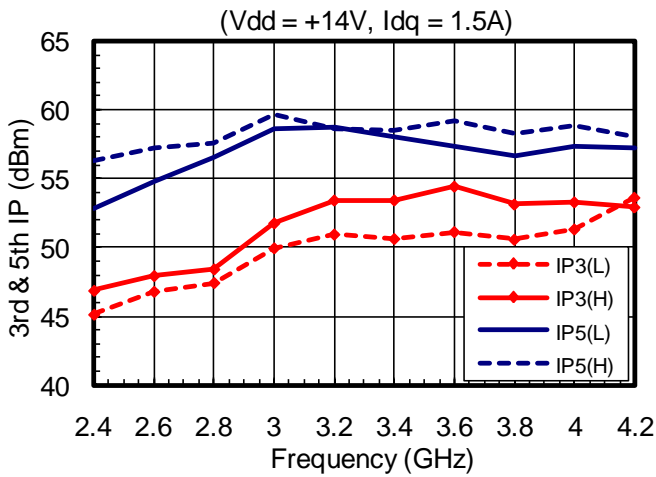

C) 3<sup>rd</sup> order & 5<sup>th</sup> order IMD

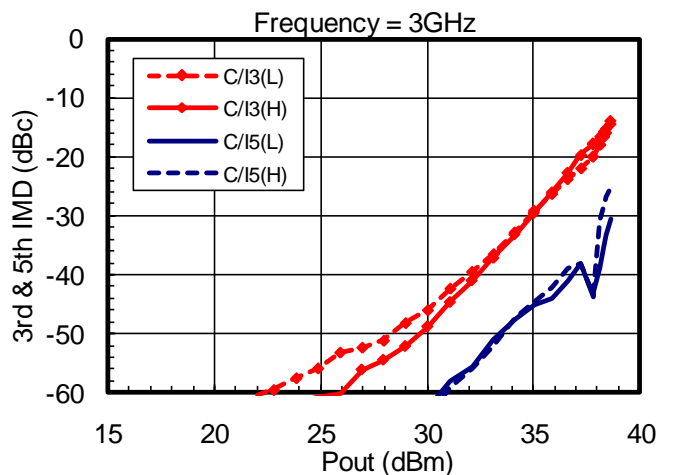
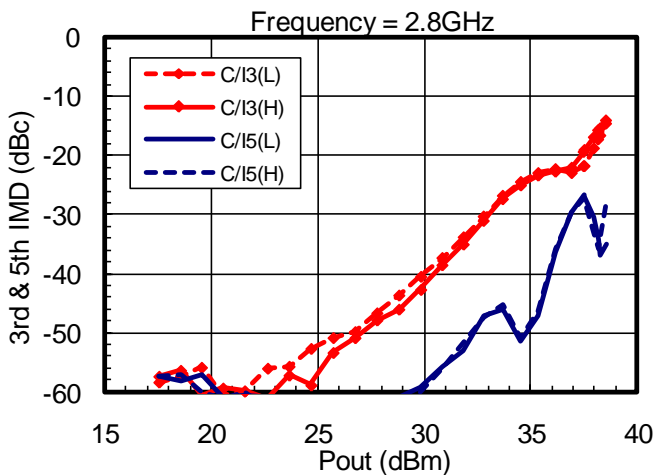

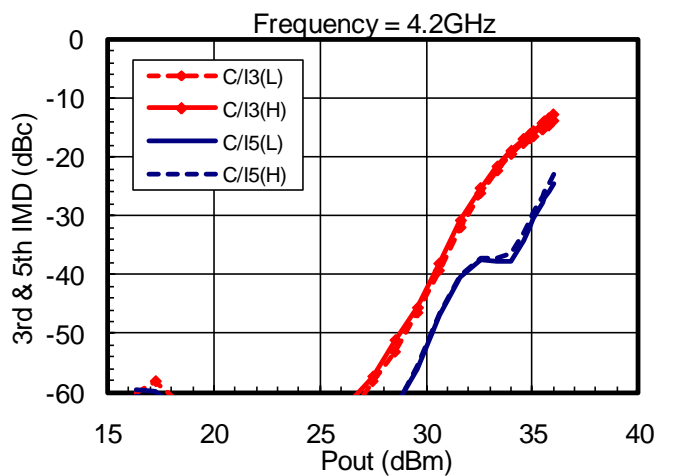
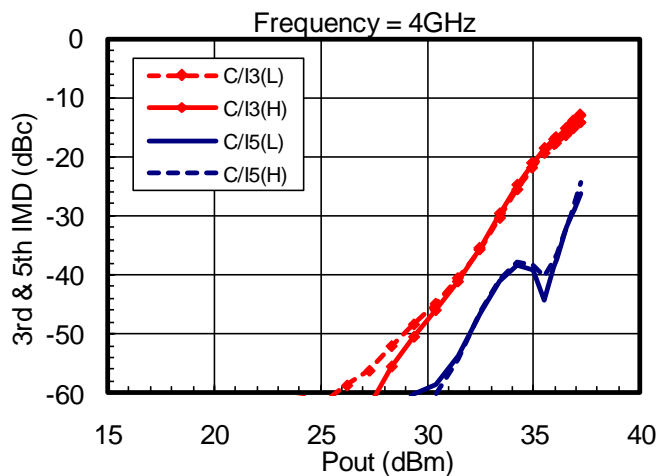
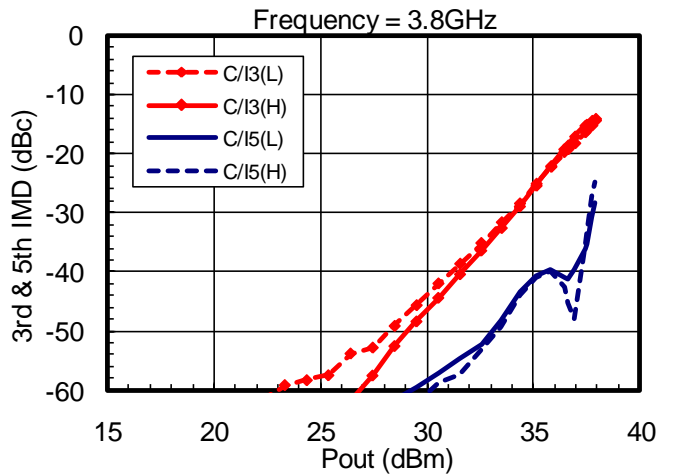
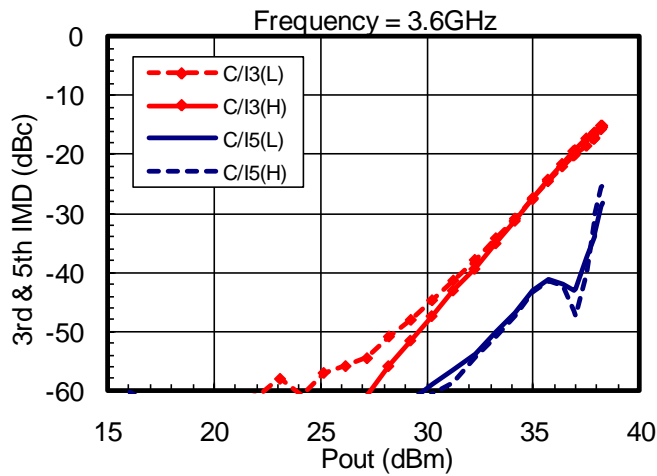
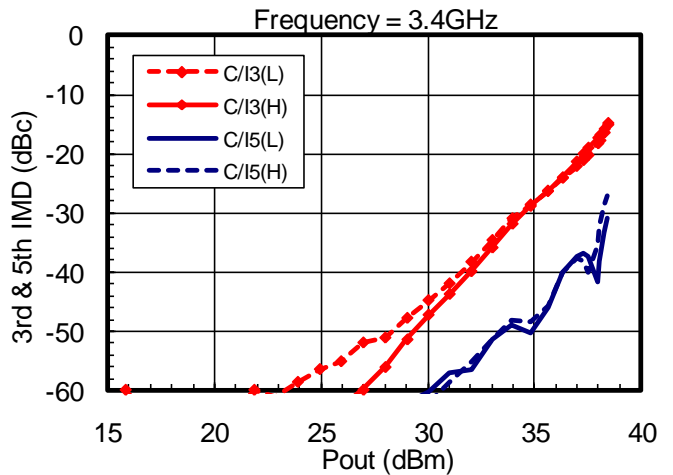
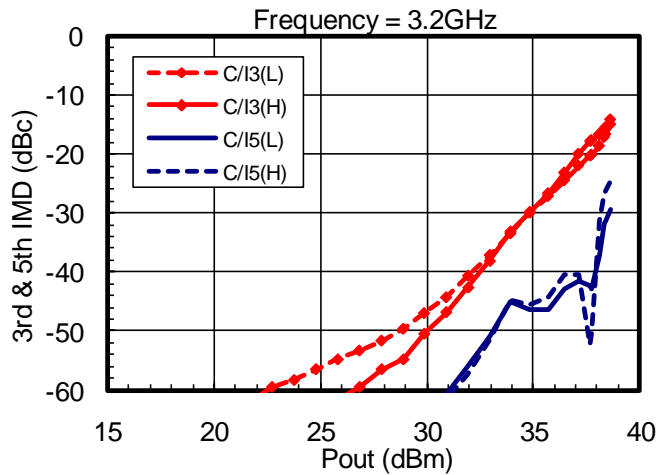

PACKAGE OUTLINE (BM)

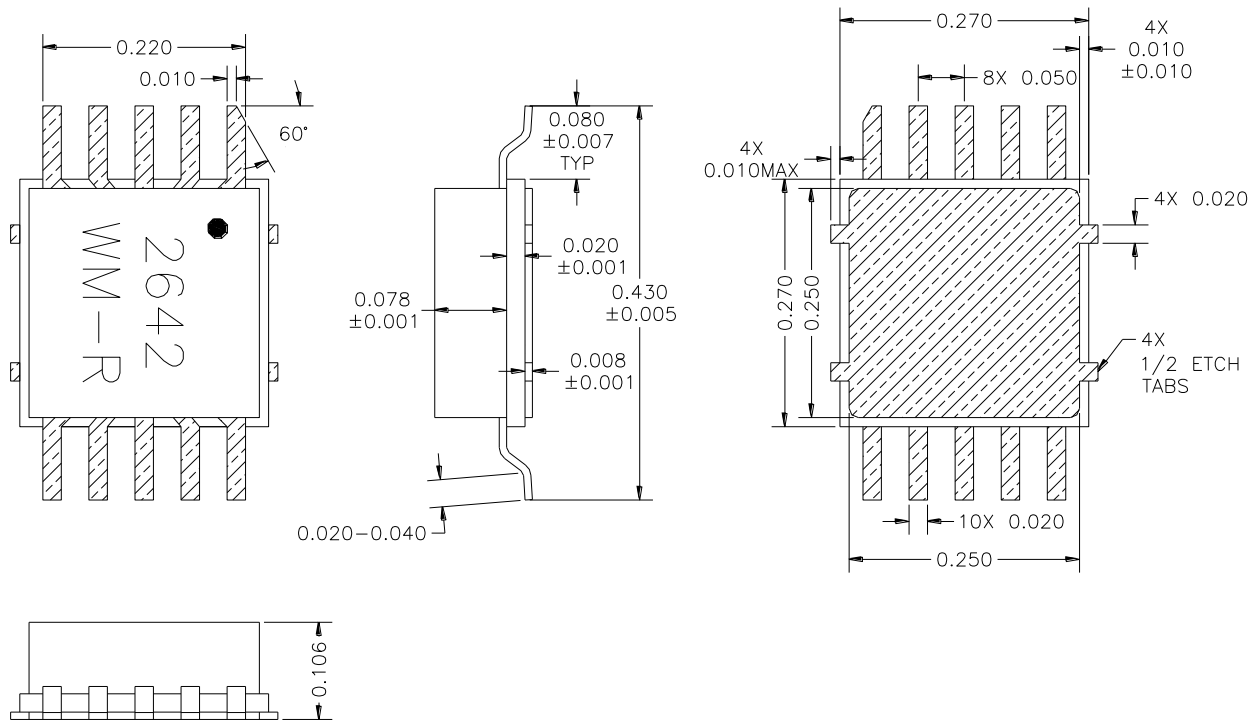

PIN LAYOUT

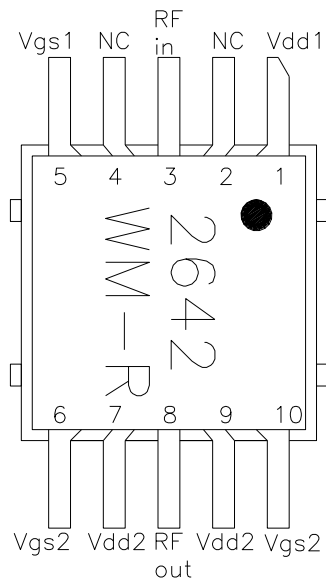

Pin No.	Function	Bias*
1	Vdd1	+14V
2	NC	
3	RF in	
4	NC	
5	Vgs1	-0.95V
6	Vgs2	-0.95V
7	Vdd2	+14V
8	RF out	
9	Vdd2	+14V
10	Vgs2	-0.95V

\*  $V_{gs1}$  &  $V_{gs2}$  may vary from lot to lot

PACKAGE OUTLINE (FM)

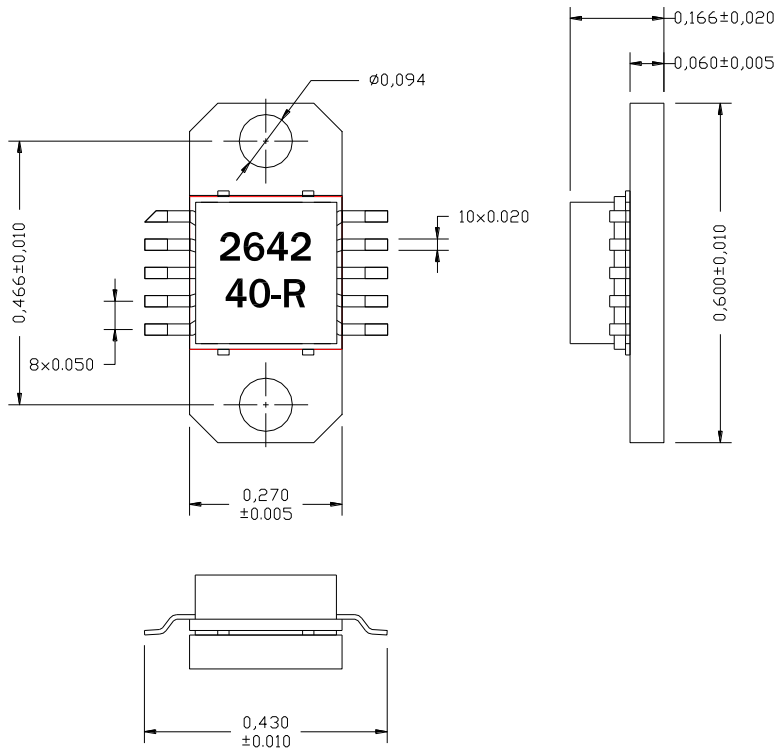

Tolerance is +/- 0.005 unless specified

PIN LAYOUT

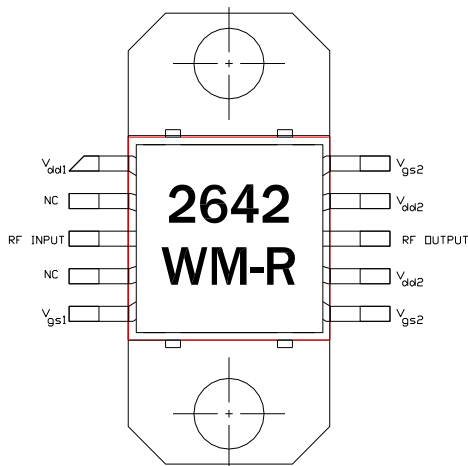

Pin No.	Function	Bias**
1	Vdd1	+14V
2	NC	
3	RF in	
4	NC	
5	Vgs1	-0.95V
6	Vgs2	-0.95V
7	Vdd2	+14V
8	RF out	
9	Vdd2	+14V
10	Vgs2	-0.95V

\* V<sub>gs1</sub> & V<sub>gs2</sub> may vary from lot to lot

TEST CIRCUIT (BM Package)

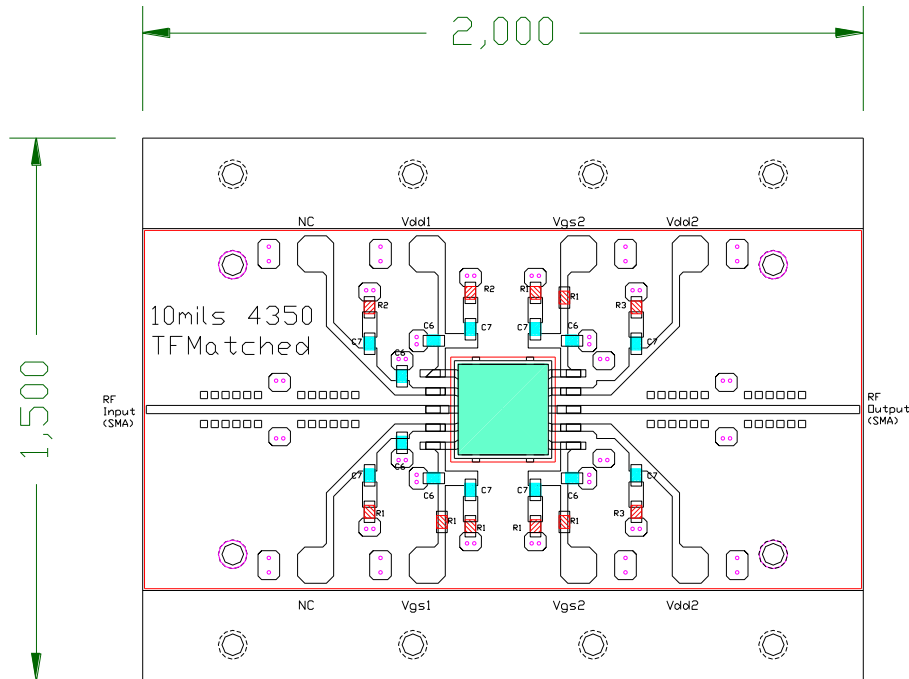

- Notes:
- 1- 10mils Rogers 4350 Material epoxied
  - 2- Ckt is for matched MMICs
  - 3- C6=20pF, C7=1000pF,  
R1=50 Ohms, R2=10 Ohms, R3=5 Ohms
  - 4- All Caps & Resistors are 0603 size

Important Notes:

- 1- The MMIC should have a good heat sink to avoid overheating. MMIC should be attached on direct ground for lowest junction temperature.
- 2- If surface mount is used, use PC board thickness < 10 mils and ensure vias are filled with solder or metal to lower PCB heat resistance. For surface mount the MMC should be de-rated to a maximum +10V bias.
- 3- Recommended current biases are 350mA & 1150mA for the first and second stages respectively.
- 4- Do not apply  $V_{dd1}$  &  $V_{dd2}$  without proper negative voltages on  $V_{gs1}$  &  $V_{gs2}$ .
- 5- The currents flowing out of the  $V_{gs1}$  &  $V_{gs2}$  pins are less than 4mA & 12mA at  $P_{1dB}$ .
- 6- External 1  $\mu$ F dipped tantalum capacitor should be attached to Vd and Vg to decouple external bias leads.

TEST CIRCUIT (FM Package)

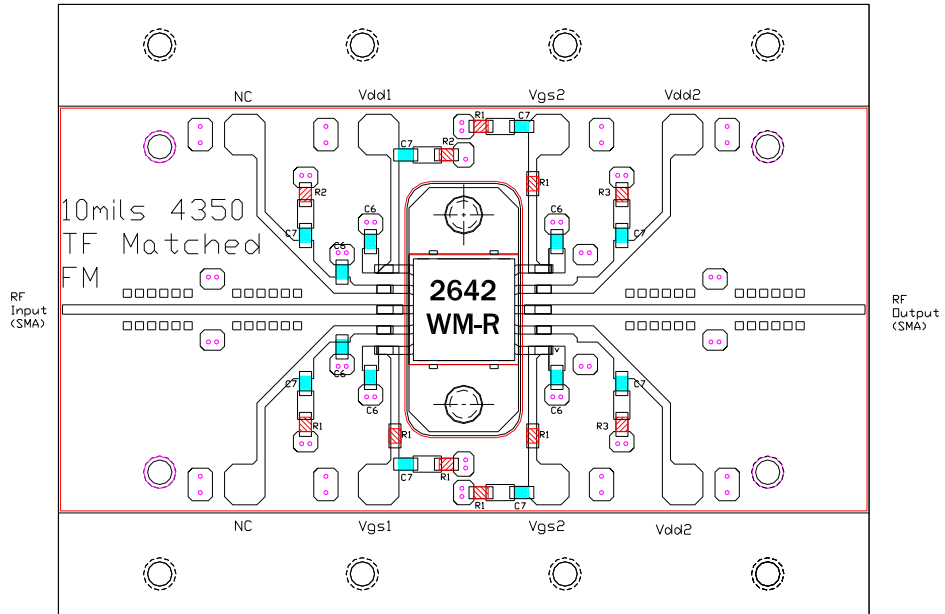

Notes:

- 1- 10mils Rogers 4350 Material epoxied
- 2- Ckt is for matched MMICs
- 3- C6=20pF, C7=1000pF,  
R1=50 Ohms, R2=10 Ohms, R3=5 Ohms
- 4- All Caps & Resistors are 0603 size
- 5- External 1  $\mu$ F dipped tantalum capacitor should be attached to Vd and Vg to decouple external bias leads.