

DESCRIPTION

AMCOM's AM204437WM-BM/FM-R is part of the GaAs MMIC power amplifier series. It has 30dB gain and 37dBm output power over the 2.2 to 4.2GHz band. This MMIC is in a ceramic package with both RF and DC leads at the lower level of the package to facilitate low-cost SMT assembly to the PC board. When mounting directly to PCB, please see application note AN700 for instructions. Because of high DC power dissipation, we strongly recommend to mount these devices directly on a metal heat sink. The AM204437WM-FM-R is the AM204437WM-BM-R mounted on a gold plated copper flange carrier. There are two screw holes on the flange to facilitate screwing on to a metal heat sink. This MMIC is RoHS compliant.

FEATURES

- Wide bandwidth from 2.0 to 4.4GHz
- High output power, $P_{sat} = 37\text{dBm}$
- High gain, 30dB
- Fully matched; 50-ohm input/output impedance

APPLICATIONS

- Wireless Internet Access
- Wireless Local Loop
- Two way radio

PERFORMANCE* ($V_{ds} = 8\text{V}$, $I_{dq} = 1800\text{mA}$, $V_{gs}^{**} = -0.66\text{V}$, $T_a = 25^\circ\text{C}$)

Parameters	Minimum	Typical	Maximum
Frequency	2.4 – 4.0GHz	2.0 – 4.4GHz	
Gain (Small signal)	26dB	30dB	
Gain Ripple		$\pm 1.0\text{dB}$	$\pm 3.0\text{dB}$
$P_{1\text{dB}}$	35.0dBm	36.0dBm	
P_{sat}		37.0dBm	
Efficiency at P_{sat}	20%	25%	
Input Return Loss	8dB	13dB	
Output Return Loss	7dB	12dB	
Thermal Resistance		4.9°C/W	

* Specifications subject to change without notice

** Gate bias is for reference only and may vary from lot to lot

ABSOLUTE MAXIMUM RATING

Parameters	Symbol	Rating
Drain source voltage	V_{ds}	10V
Gate source voltage	V_{gs}	-5V
Drain source current	I_{ds}	2.5A
Continuous dissipation at room temperature	P_t	30W
Channel temperature	T_{ch}	175°C
Operating temperature	T_{op}	-55°C to +100°C
Storage temperature	T_{sto}	-55°C to +135°C

SMALL SIGNAL DATA

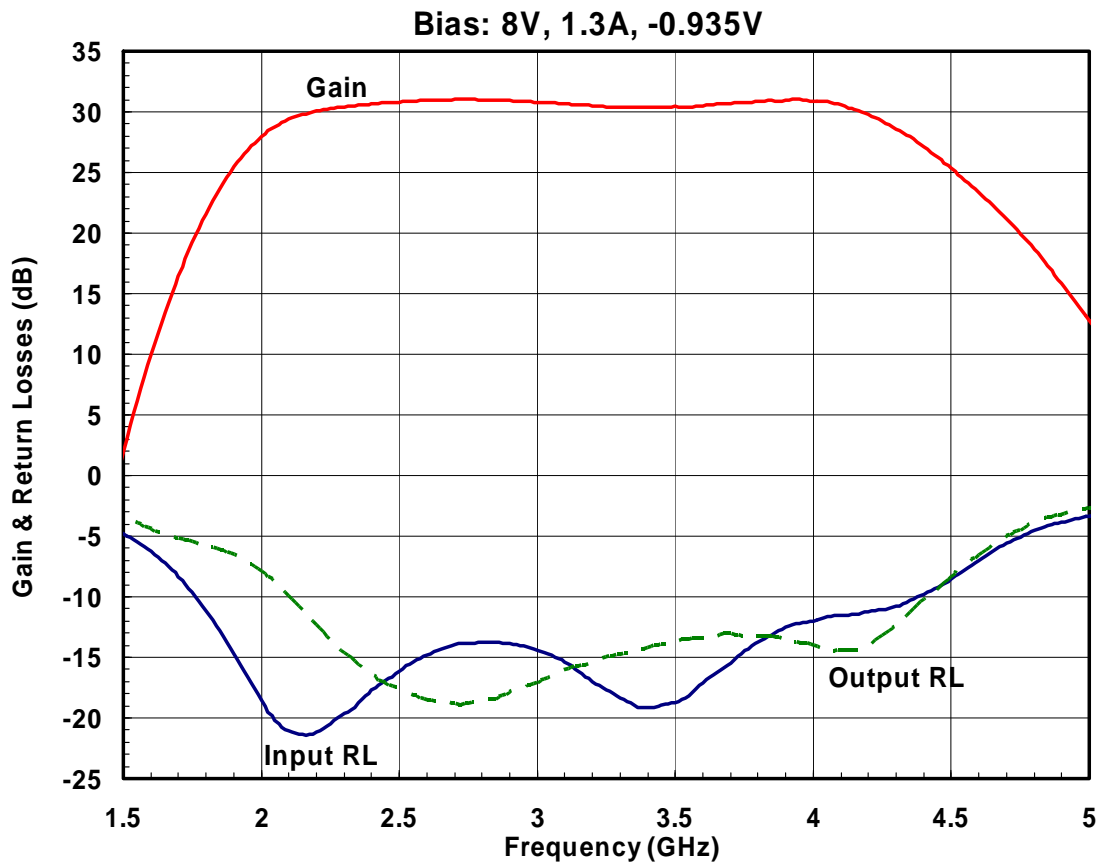

POWER DATA

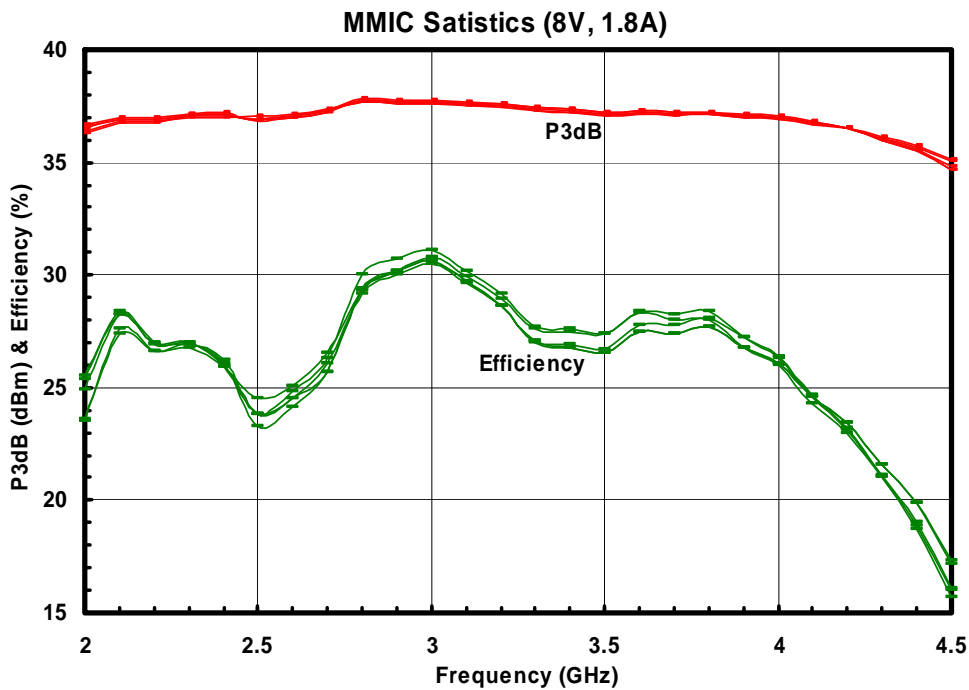
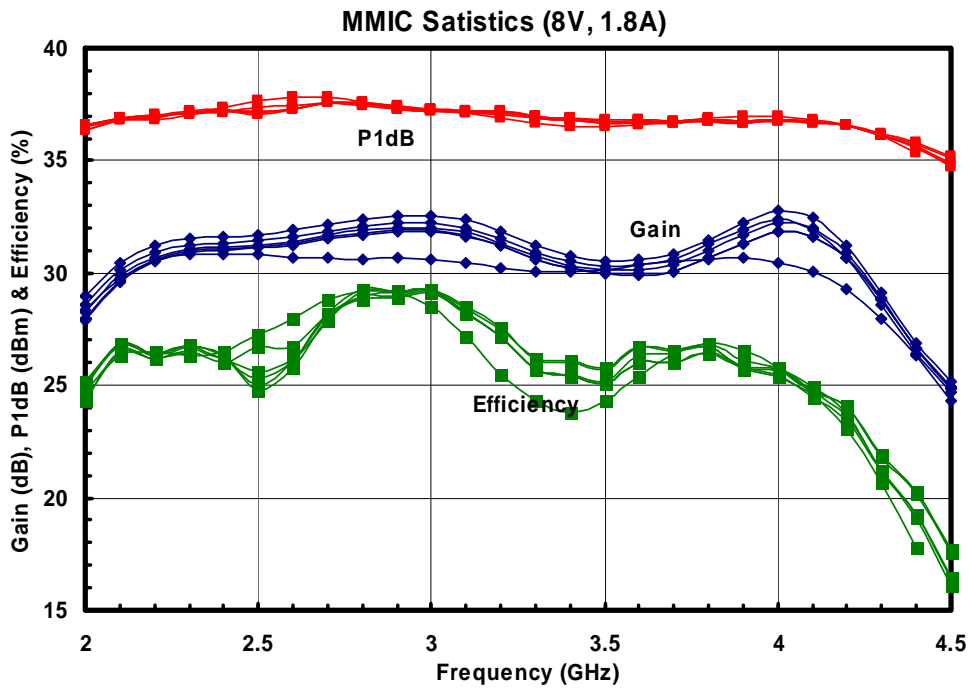

PACKAGE OUTLINE (BM)

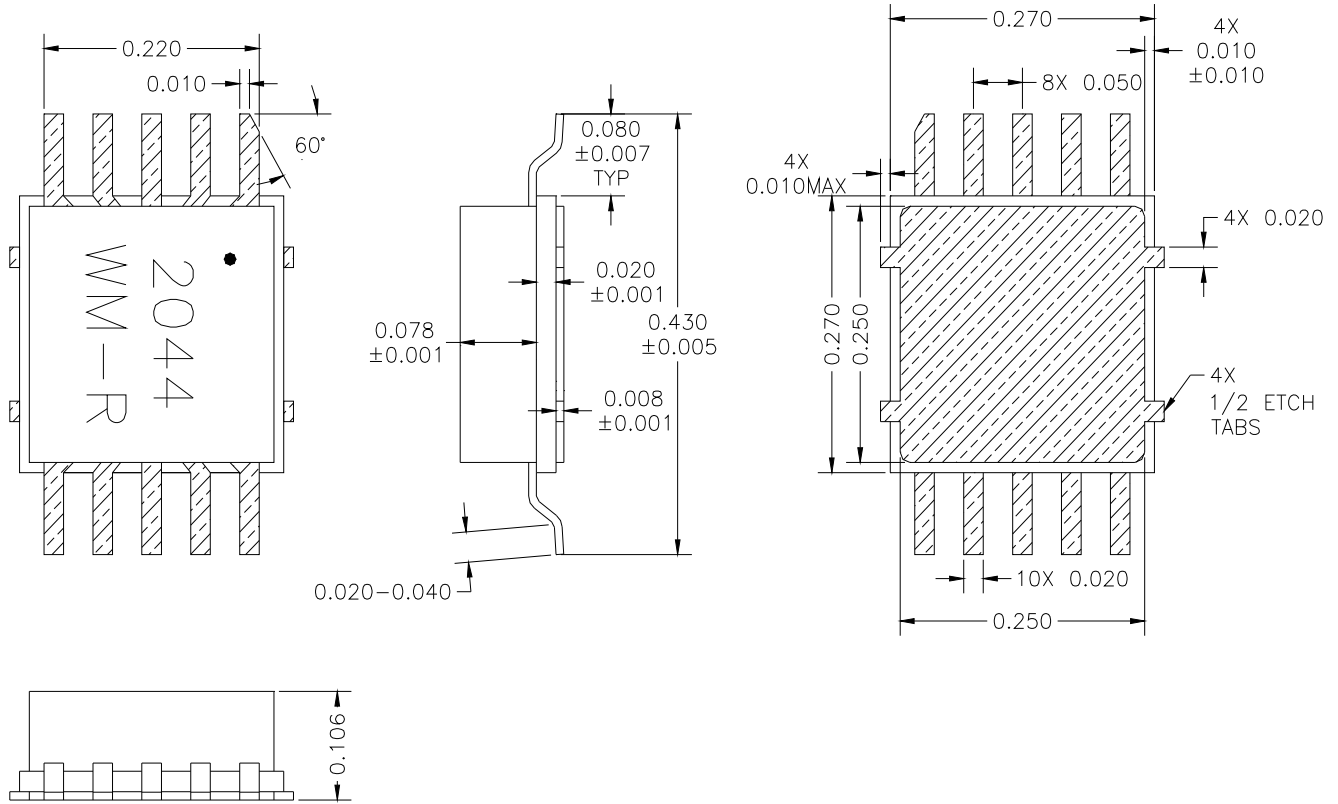

PIN LAYOUT

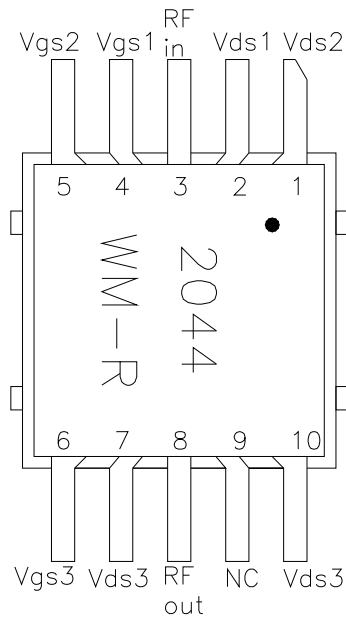

Pin No.	Function	Bias*
1	Vds2	+8V
2	Vds1	+8V
3	RF in	
4	Vgs1	-0.66V
5	Vgs2	-0.66V
6	Vgs3	-0.66V
7	Vds3	+8V
8	RF out	
9	NC	
10	Vds3	+8V

* V_{gs1}, V_{gs2}, & V_{gs3} may vary from lot to lot

PACKAGE OUTLINE (FM)

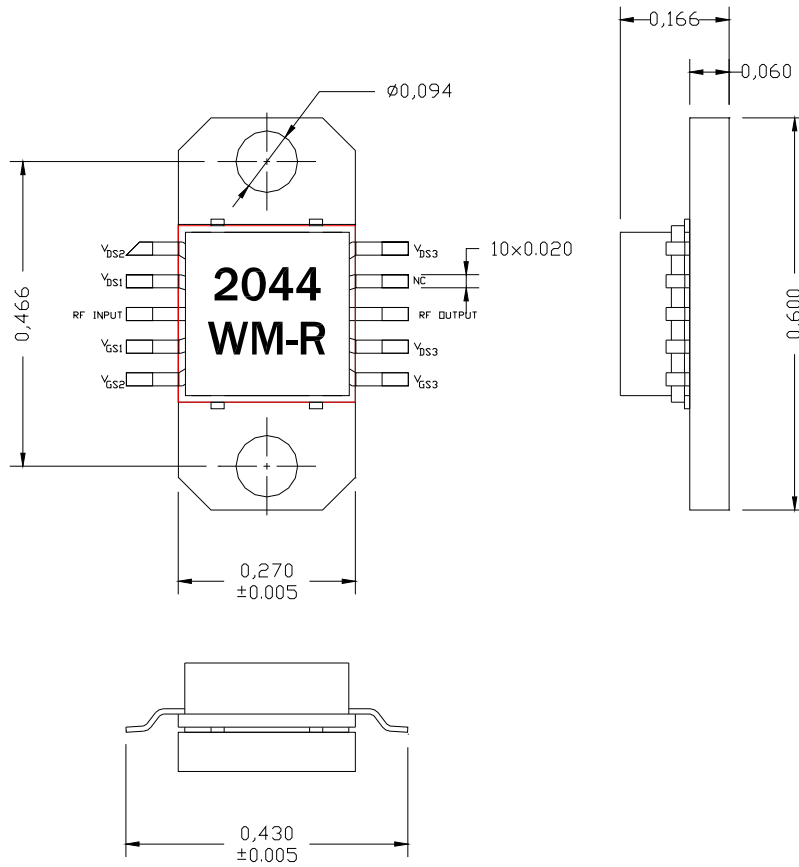

PIN LAYOUT

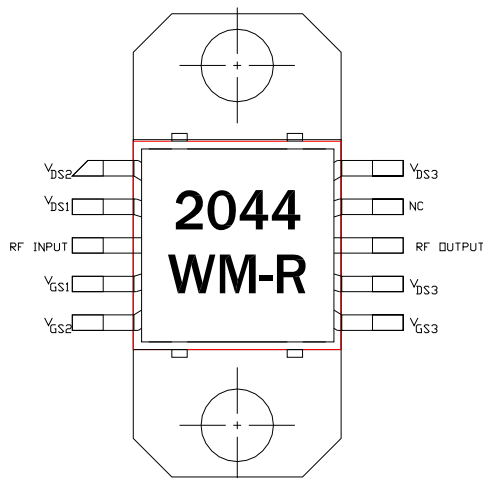

Pin No.	Function	Bias*
1	Vds2	+8V
2	Vds1	+8V
3	RF in	
4	Vgs1	-0.66V
5	Vgs2	-0.66V
6	Vgs3	-0.66V
7	Vds3	+8V
8	RF out	
9	NC	
10	Vds3	+8V

* V_{gs1}, V_{gs2}, & V_{gs3} may vary from lot to lot

TEST CIRCUIT OUTLINE (BM Package)

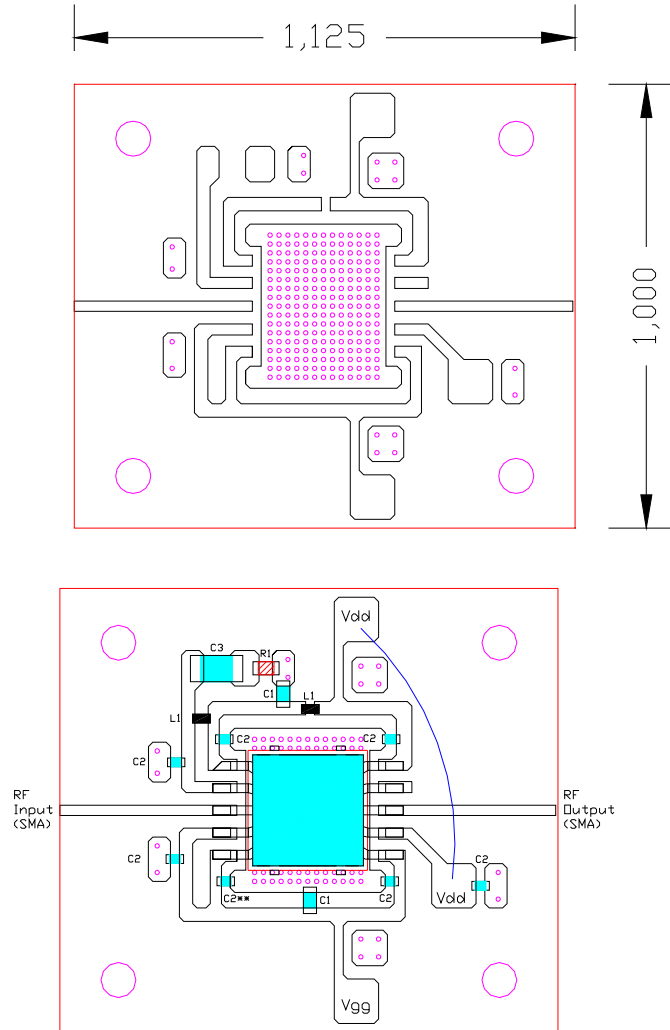

Notes:
 1- 10mils Rogers 4350 Material epoxied to D0007-0021A
 2- Ckt is for matched MMICs
 3- C1=0.56uF (0603), C2=1000pF (0402), C3=10uF (1206), R1=3 ohms (0603), L1=1nH (0402), ** May be omitted

Important Notes:

- 1- The MMIC should have a good heat sink to avoid overheating. If SMT is used use PC board thickness < 10 mils and ensure vias are filled with solder or metal to lower PCB heat resistance. MMIC could be attached on direct ground for lowest junction temperature.
- 2- Recommended current biases are 100mA, 300mA & 1400mA for the first, second and third stages respectively.
- 3- Do not apply V_{ds1} , V_{ds2} & V_{ds3} without proper negative voltages on V_{gs1} , V_{gs2} & V_{gs3} .
- 4- The currents flowing out of the V_{gs1} , V_{gs2} & V_{gs3} pins are less than 100 μ A, 600 μ A & 12mA at P_{1dB} .
- 5- External 1 μ F dipped tantalum capacitor should be attached to Vd and Vg to decouple external bias leads.